

# Audible/Visible Appliance Reference Guide

# Audible/Visible Appliance Reference Guide

## Contents

Introduction.....	1
What Is Required To Comply? .....	2
What Is The ADAAG?.....	2
What Is The Coverage and Enforcement of the ADA? .....	3
What Is “Public Mode” vs. “Private Mode” Operation? .....	3
Visible Signaling Appliance Requirements .....	4
Where Should Strobes Be Located?.....	5
How Many Strobes Should Be Used? .....	6
Ceiling-Mounted Visual Alarm Appliances and the ADA.....	7-8
What About Photosensitive Epilepsy and Strobe Flash Rates? .....	8
Audibility Requirements .....	9-10
Voltage Drop Calculations.....	10
Power Supply Considerations .....	11
What Is Meant By Polar Light Distribution? .....	11
Glossary.....	12

## Introduction: The Need for an Audible/Visible Compliance Reference Guide

The installation and performance requirements for audible/visible appliances in general are addressed in three documents: 1. ADAAG, ‘Americans with Disabilities Act Accessibility Guidelines’, the Federal Civil Rights Law prohibiting discrimination on the basis of disability, 2. ANSI 117.1–2003 ‘Accessible and Usable Buildings and Facilities’, a standard on accessibility designed to be adopted as part of a building code, and 3. NFPA 72, the National Fire Alarm Code, 2007 edition, an installation standard for fire alarm systems normally not adopted directly into law, but referenced in a building code as the standard to be followed.

Currently, the NFPA 72 and IFC 2006 Edition/ANSI–2003 have been harmonized. Chapter 7 of ANSI 117.1-2003 (Communication and Element Features) section 702.1 “Accessible audible and visual alarms and notification appliances shall be installed in accordance with NFPA 72 listed in Section 105.2.2, be powered by a commercial light and power source, be permanently connected to the wiring of the premises electric system, and be permanently installed.” Therefore, the standards are consistent in regards to the type, visual intensity, and amount of visual alarm notification appliances, i.e. strobes, to use within a given space, as well as the mounting and placement of such appliances. The current ADAAG, however, has not been updated since its initial publication in 1991 and does not reflect recent technological advances within the industry. As such, the current version of the ADAAG is not harmonized with the NFPA72, 2007 edition, and IFC 2006 Edition/ANSI–2003. As a result, the ADAAG provides differing guidelines as regards strobe selection from those of the two harmonized codes.

On November 16, 1999, the Access Board, an independent Federal agency devoted to accessibility for people with disabilities, published a proposed rule in the Federal Register to change the ADA Accessibility Guidelines (ADAAG). These updated guidelines, if adopted by the Department of Justice after a period of public review and commentary, would be the first comprehensive update of the ADAAG since its initial publication in July 1991. However, until adopted, the current (1991) version of the ADAAG remains in effect.

System Sensor has prepared this Reference Guide in an effort to help promote understanding and awareness of the issues that affect specifying engineers, installers, and the enforcement authorities. We hope to increase the probability of proper installation and reduce the possibility of misapplication of audible/visible appliances in the commercial market place.

### What Is Required To Comply?

Due to differing codes and standards, compliance entails meeting all of the ADA requirements or providing “equivalent facilitation” as well as adhering to NFPA 72, installation, and UL 1971, performance standards. It is always prudent to consult with your Authority Having Jurisdiction (AHJ) and/or local fire marshal to ensure that you are meeting all applicable codes and standards. The diagram to the right illustrates the five steps to compliance.

### Equivalent Facilitation

Currently, equivalent facilitation is stated as follows per NFPA: “Departures from particular technical and scoping requirements of this guideline by the use of other designs and technologies are permitted where the alternative designs and technologies used will provide substantially equivalent or greater access to and usability of the facility.”

The Access Board, also known as the Architectural and Transportation Barriers Compliance Board, advises that “...by varying lamp intensity and spacing, systems designers can tailor an installation to the physical conditions of the space being served.” However, the Access Board goes on to caution that it is impossible to provide specific guidance for the design of non-standard installations based upon the photometry calculations necessary to demonstrate equivalent facilitation.

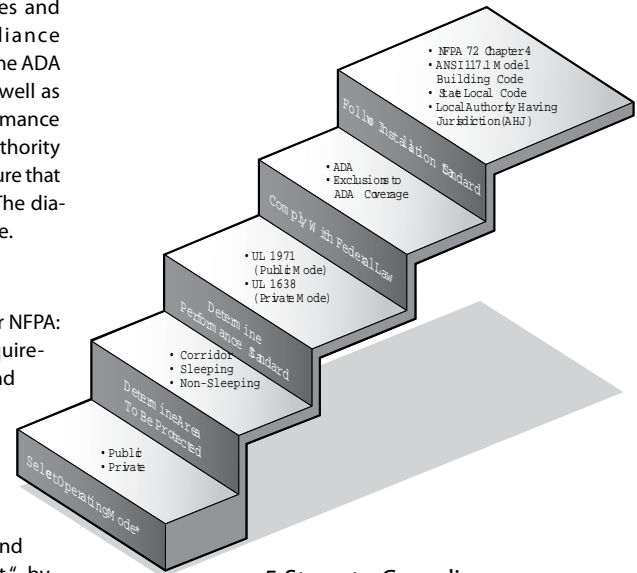

5 Steps to Compliance

In the proposed Americans with Disabilities Act Accessibility Guideline (ADAAG), Equivalent Facilitation verbiage has been simplified and is more user friendly. Specifically, “Nothing in these guidelines is intended to prevent the use of designs or technologies as alternatives to those prescribed in this document, provided they provide equivalent or superior accessibility and usability.”

### What Is The ADAAG?

The ADAAG is the official standard for accessible design under Title III of the ADA. It covers only new construction and alterations made to the fire alarm system undertaken by facilities covered by the ADA. The ADAAG was written by the Access Board. The Access Board, in one of its information bulletins, states: “Because the ADA is civil rights law, compliance with and enforcement of its implementing regulations are not overseen by a local building code official, but are exercised through private suit or by specified federal agencies when discrimination—or the probability of discrimination on the basis of disability—is alleged.”

A few states have adopted ADAAG as their accessibility code and implement its provisions through state and local building code officials in the same way as other applicable building regulations are applied, reviewed and enforced. Many jurisdictions



are expected to submit their building codes and/or standards for review by the Department of Justice. Standards that meet or exceed the minimum accessibility requirements of the ADA will be certified. The model codes, including ANSI 117.1, have sought to coordinate accessibility provisions through informal review and technical assistance from DOJ.

ADA/ADAAG compliance does not relieve the designer from complying with the provisions of a state or local access code. “Where such a code contains more stringent requirements, they must be incorporated. Conversely, adoption of ADAAG or certification of the equivalence of a state/local code will not relieve covered entities of their responsibilities to meet the accessibility standards imposed by the ADA.”

The ADA comprises four titles that define and prohibit discrimination on the basis of disabilities within specific areas. Fire

- Exclusions to ADA Coverage:
- Individual employee offices and work stations. Arrangements should be made, however, to comply with the provisions of Title I, which addresses providing reasonable accommodations; e.g., a visible signal for an employee who is deaf or hard of hearing.
  - Religious entities and private clubs.
  - Strictly residential private apartments and homes.
  - Federal buildings covered by the Architectural Barriers Act of 1968 [ABA] and, currently, by the Uniform Federal Accessibility Standards [UFAS]; a corporation wholly owned by the government of the U.S., or an Indian tribe.
  - Multi-family residential facilities (generally covered by the Fair Housing Amendments Act of 1988 [FHAA] and its related regulations and standards).

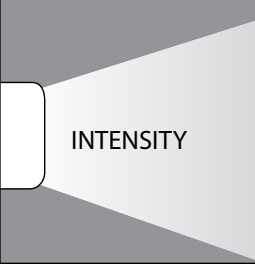
## Visible Signaling Appliance Requirements

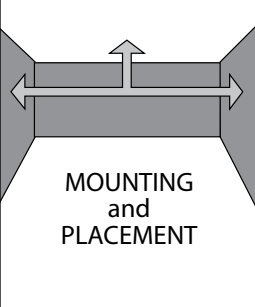
REQUIREMENT	AREA TO BE PROTECTED	ADA CURRENT	ADA ANTICIPATED	UL 1971	ANSI 117.1	NFPA 72
 LIGHT DISTRIBUTION		No Specific Requirement	Per UL 1971	"Polar" Distribution <sup>1</sup>	Per UL 1971	Per UL 1971
 INTENSITY	Non-Sleeping Area	75 cd (50' spacing)	15 cd Minimum <sup>4,5</sup>	15 cd Minimum <sup>4,5</sup>	15 cd Minimum <sup>4,5</sup>	15 cd Minimum <sup>4,5</sup>
	Sleeping Area	75 cd (50' spacing)	110 cd (wall) 177 cd (ceiling)	110 cd (wall) <sup>2</sup> 177 cd (ceiling)	110 cd (wall) <sup>2</sup> 177 cd (ceiling)	110 cd (wall) <sup>2</sup> 177 cd (ceiling)
	Corridor Area	75 cd (50' spacing)	15 cd (100' spacing)	15 cd	15 cd (100' spacing)	15 cd (100' spacing)
 FLASH RATE		1 to 3 Hz <sup>3</sup>	1 to 2 Hz <sup>3</sup>	1 to 2 Hz <sup>3</sup>	1 to 2 Hz <sup>3</sup>	1 to 2 Hz <sup>3</sup>
 MOUNTING and PLACEMENT	Non-Sleeping & Corridor Area	Lower of 80" above floor or 6" below ceiling	Wall: 80" to 96" above floor, 6" min. below ceiling. On ceilings less than 30" <sup>5</sup>	No Specific Requirement	Wall: 80" to 96" above floor, 6" min. below ceiling. On ceilings less than 30" <sup>5</sup>	Wall: 80" to 96" above floor, 6" min. below ceiling. On ceilings less than 30" <sup>5</sup>
	Sleeping Area	Lower of 80" above floor or 6" below ceiling	110 cd required if greater than or equal to 24" below ceiling; 177 cd required if less than 24" below ceiling	110 cd required if greater than or equal to 24" below ceiling; 177 cd required if less than 24" below ceiling	110 cd required if greater than or equal to 24" below ceiling; 177 cd required if less than 24" below ceiling	110 cd required if greater than or equal to 24" below ceiling; 177 cd required if less than 24" below ceiling
	Placement	Wall Only	Wall or Ceiling	Wall or Ceiling	Wall or Ceiling	Wall or Ceiling

Notes:

<sup>1</sup> UL 1971 requires specific light intensities at viewing angles ranging from 0 to 90 degrees off axis.

<sup>2</sup> If detector and visible device are in same sleeping room intensity is required to be 177 cd.

<sup>3</sup> 1/3 Hz equals 20 flashes per minute; 1 Hz equals 60 flashes per minute; 3 Hz equals 180 flashes per minute.

<sup>4</sup> Intensity dependent upon room size.

<sup>5</sup> Where the ceiling strobe is not located in the center of the room, the candela level shall be determined by doubling the distance from the appliance to the farthest wall to obtain the maximum room size.

According to the ADAAG, "ADA compliant visual alarms are not required in alterations, except where an existing fire alarm system is upgraded or replaced, or a new fire alarm system is installed." The ADAAG goes on to define an alteration as "A change to a building or facility that affects or could affect the usability of the building or facility or part thereof. Alterations include, but are not limited to, remodeling, renovation, rehabilitation, reconstruction, historic restoration, changes or rearrangement of the structural parts or elements, and changes or rearrangement in the plan configuration of walls and full-height partitions. Normal maintenance, re-roofing, painting or wallpapering, or changes to mechanical and electrical systems are not alterations unless they affect the usability of the building or facility."

## Where Should Strobes Be Located?

encompass the entire room is to be used (see Figure 1).

NFPA requires strobes to be located so that the illumination can be seen regardless of the viewer's orientation, with maximum spacing between devices (like the ADA), not to exceed 100' (see Figure 2).

### Non-Sleeping Rooms

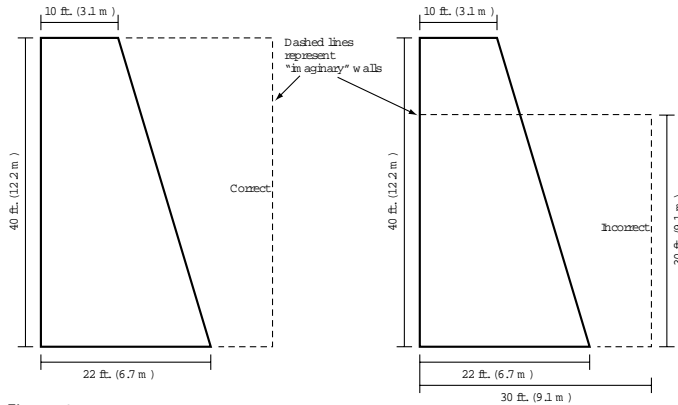

Figure 1

In non-sleeping areas the NFPA requires that wall mount visible notification appliances be installed 80" to 96" above the floor (6" minimum below the ceiling) and for ceiling mounted strobes, no more than 30' above the floor.

The NFPA specifies varying minimum required light outputs for non-sleeping rooms (shown in the table below).

### Corridor Spacing for Visible Appliances

For corridors, NFPA specifies strobe location not more than 15' from the end of the corridor, with a maximum separation of 100'. Corridor spacing of strobes is specified as shown in

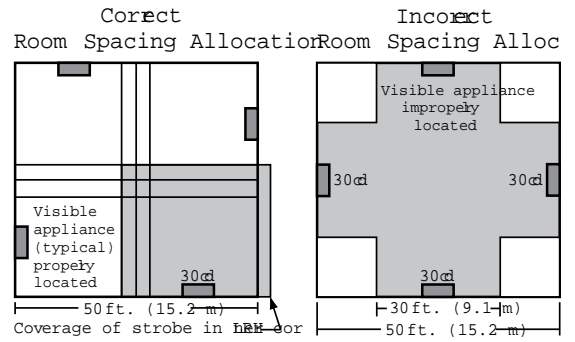

Figure 2

distance would be more than 24" to the ceiling, light intensities of 110 cd may be provided (see Figure 3).\*

The NFPA is very specific with respect to strobe count and spacing using room size as the determining variable. Four different strobe count and spacing solutions are offered in conjunction with requirements for sleeping area

Distance from Ceiling to Center of Lens	Intensity
Greater than or equal to 24" (610 mm)	110 cd
Less than 24" (610 mm)	177 cd

\*NOTE: If the room is larger than 16'x16', the appliance shall be located within 16' of the pillow measured horizontally.

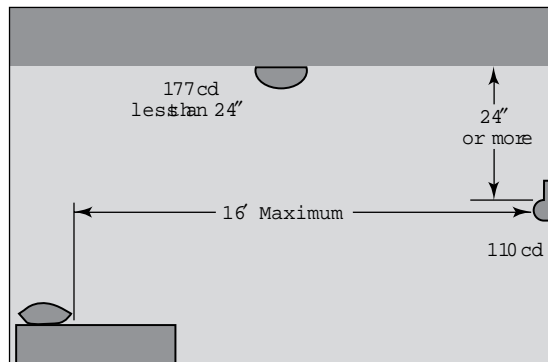

Figure 3

Table 1 below. Typical corridor placement is shown in Figure 4 at right.

### Sleeping Rooms

In sleeping areas, where the mounting height is within 24" or less of the ceiling, the required intensity is 177 cd. When the

Table 1. Minimum Number of 15 cd Strobes by Corridor Length

Corridor Length	Number of Strobes					
	1	2	3	4	5	6
0-30'						
31-130'						
131-230'						
231-330'						
331-430'						
431-530'						

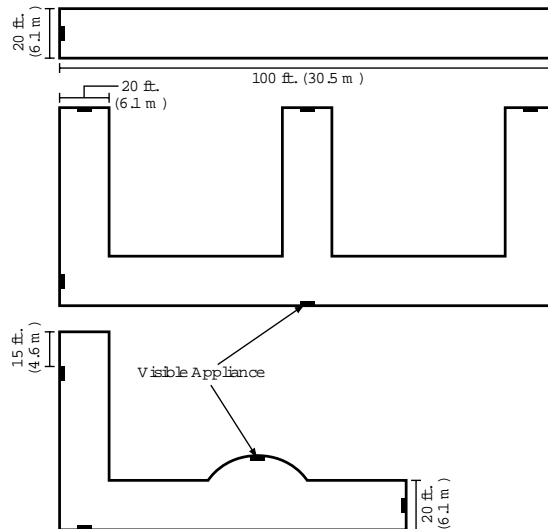

Figure 4

### How Many Strobes Should Be Used?

tion with tables 7.5.4.3.1(a), 7.5.4.3.1(b) and figure 7.5.4.3.1 in this section of NFPA 72

4. More than two visible notification devices or groups of synchronized appliances in the same room or adjacent space within the field of view that flash in synchronization.

2007:

1. Use a single visible notification appliance.
2. Use two visible notification appliances located on opposite walls.
3. Two groups of visual notification appliances, where visual appliances of each group are synchronized, in the same room or adjacent space within the field of view. This shall include synchronization of strobes operated by separate systems.

\* Field of view= 135°

### Wall Mount

Minimum Light Output Per Strobe by Room Size (Non-Sleeping)

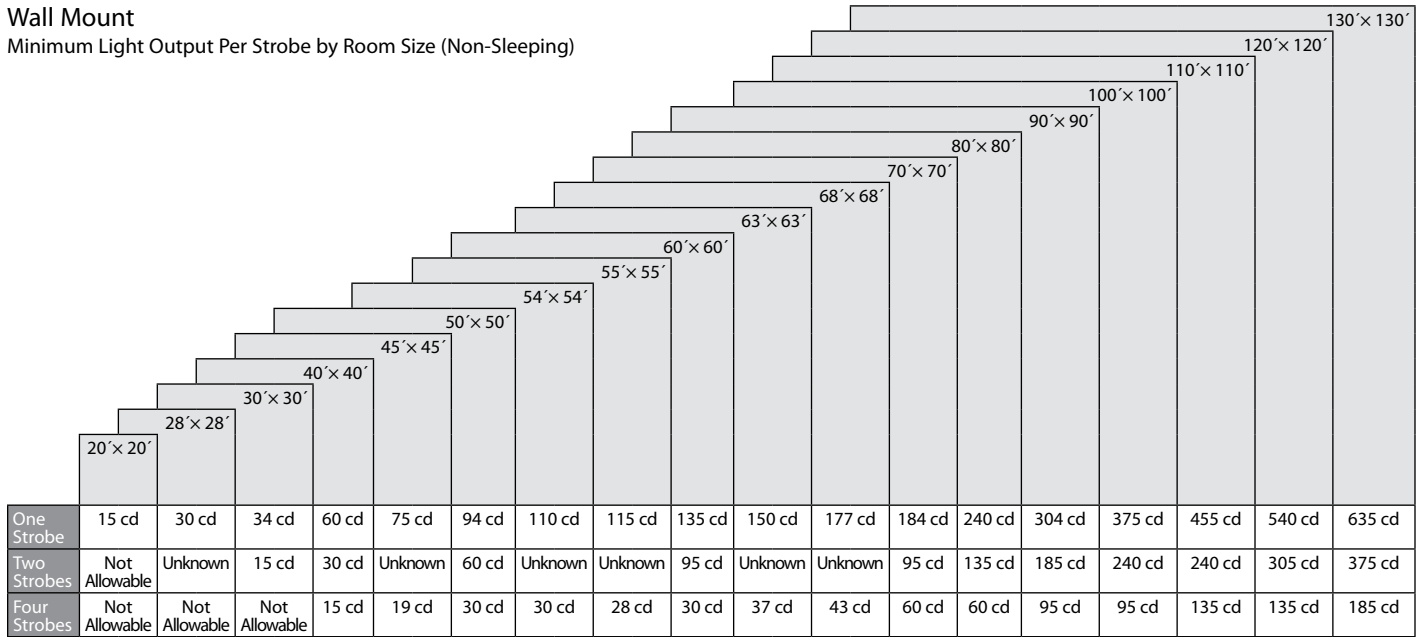

## Usage of Ceiling-Mounted Visual Alarm Appliances as Prescribed by Key Standards, Laws, and Codes

The installation and performance requirements for audible/visible appliances in general are addressed in three documents: 1. ADA, a civil rights law prohibiting discrimination on the basis of disability; 2. IFC 2006 Edition/

ANSI 117.1–2003 ‘Accessible and Usable Buildings and Facilities’, a standard on accessibility designed to be adopted as part of a building code; and, 3. NFPA 72, the National Fire Alarm Code, 2007 edition, an installation standard for fire alarm systems normally not adopted directly into law, but referenced in a building code as the standard to be followed.

From a building design and construction standpoint, IFC 2006 Edition/ANSI A117.1–2003 and NFPA 72, 2007 edition, both recognize ceiling-mount visual alarm appliances and describe the requirements for intensity, mounting, and placement for such appliances. The current version of the ADAAG (1991) does not. While compliance with all three is generally required, the only method to satisfy the requirements of ANSI A117.1/NFPA 72 and the ADAAG, and thus to be able to install ceiling-mounted appliances, is to claim equivalent facilitation, which is not currently allowed by ADA (though it may soon be allowed). Or, ask for a variance from the Authority Having Jurisdiction.

The definition of equivalent facilitation is provided within Chapter 1, Section 103 of the ADAAG, which states the following:

“Alternatives to specific requirements that provide equal or greater access are permitted. This provides flexibility for new technologies and innovative design solutions that may not have been taken into account when the ADAAG was developed.”

## ADAAG and Ceiling-Mount Visual Alarm Appliances

The ADAAG has great importance to members of the fire alarm industry because it is used as a reference to define the provisions for accessibility within the design and construction of accessible buildings. However, the ADAAG has not been updated since 1991 and does not reflect recent technological advances within the industry. These advances improved the ability of fire alarm devices, in general, and audible/visible devices, in particular, to provide notification of a fire condition and the need to evacuate an area. Since the introduction of the ADAAG, the industry has made significant advances in the design of audible/visible appliances, specifically in the area of ceiling-mounted devices, which are not addressed by the current ADAAG.

On November 16, 1999, a proposed update of the ADAAG was published in the Federal Register for public comment. The intent is to harmonize the ADAAG with the model codes and the national standard, as well as to reflect technological developments, such as ceiling-mounted devices, that have occurred since the current 1991 version, while continuing to meet the needs of people with disabilities. The proposed version of the ADAAG addresses ceiling-mounted audible/visible devices, in terms of installation and performance, in a manner that is generally consistent with the current

versions of NFPA72 and ICC/ANSI A117.1. However, the proposed update has not been adopted into law, and until such time the current ADAAG (1991) remains in effect, and equivalent facilitation must be demonstrated in order to use ceiling-mounted devices in those installations requiring compliance with the ADAAG.

## ANSI A117.1-2003 and NFPA 72 Harmonized

The American National Standards Institute Document ANSI A117.1, since its introduction in 1961, has served to present the criteria for accessibility for building design. The current version of the standard, ICC/ANSI A117.1–2003 refers to NFPA 72 for the mounting locations, spacing allocations, and minimum effective intensities for ceiling-mounted devices. In the 2007 Edition of NFPA 72, if ceiling heights exceed 30 feet, ceiling mounted visible notification appliances shall be suspended at or below 30 feet, or wall-mounted visible notification appliances shall be installed. Table 7.5.4.1(b) Room Spacing for (Ceiling-Mounted Visible Appliances) shall be used if the ceiling mounted visible notification appliance is at the center of the room. If the ceiling-mounted visible notification appliance is not located at the center of the room, the effective intensity (cd) shall be determined by doubling the distance from the appliance to the farthest wall to obtain the maximum room size.

This standard (ICC/ANSI A117.1 - 2003) “is available for adoption and use by jurisdictions internationally. Its use within a governmental jurisdiction is intended to be accomplished through adoption by reference in accordance with proceedings establishing the jurisdiction’s laws.”

**Ceiling Mount**  
Minimum Light Output by  
Room Size (Non-Sleeping)

	20' x 20'	30' x 30'	50' x 50'	70' x 70'
10' Ceiling	15 cd	30 cd	95 cd	185 cd
20' Ceiling	30 cd	45 cd	95 cd	185 cd
30' Ceiling	55 cd	75 cd	95 cd	185 cd

Where ceiling heights exceed 30' the NFPA states, “Visible signaling appliances shall be suspended at or below 30' or wall mounted.” Candela requirements for ceiling strobes, presented in the table above, assume location of the strobe in the center of the room. “Where it is not located in the center of the room, the candela level shall be determined by doubling the distance from the appliance to the farthest wall to obtain the maximum room size.”

### Conclusion

From a building design and construction standpoint, ANSI A117.1, the building standard for accessibility and NFPA 72, the National Fire Alarm Code, both recognize ceiling-mount visual alarm appliances and describe the requirements for intensity, mounting, and placement for such appliances. As noted, the current version of the ADAAG (1991) does not. While compliance with all three is generally required, the only method to satisfy the requirements of ANSI A117.1/ NFPA 72 and the ADAAG, and thus to be able to install ceiling-mounted appliances, is to claim equivalent facilitation.

Equivalent facilitation, as defined in the current ADAAG Chapter 1, Section 103, states “alternatives to specific require-

ments that provide equal or greater access are permitted”. The ADAAG further states that equivalent facilitation “provides flexibility for new technologies and innovative design solutions that may not have been taken into account when ADAAG was developed”.

Equivalent facilitation, in the instance of visual alarm appliances, may be used to demonstrate that any proposed substitute will deliver the minimum illumination (or light intensity) requirements. The use of ceiling-mounted visual alarm appliances in lieu of wall-mounted appliances, as supported by a demonstration of equivalent facilitation, requires the approval of the appropriate authority having jurisdiction (AHJ).

### What About Photosensitive Epilepsy and Strobe Flash Rates?

People who are vulnerable to photosensitive epilepsy have voiced concern over the cumulative effect of seeing multiple flashing strobes in the field of view.

An example of this would be an individual standing at the cross-point of an “L” shaped corridor that contains multiple strobes. During an alarm or test of a system, the person could be exposed to a cumulative flash rate that might increase the probability of seizure and photosensitive response.

Although aggregate strobe flash rates in a fire alarm system and their relationship to those persons with photosensitive epilepsy are not directly referenced in any current law or standard, it is an issue that should be addressed with

diligence when installing and/or upgrading fire alarm systems.

Although one solution involves synchronized (simultaneous flashing) strobes, other options have been outlined by NFPA and the proposed ADAAG. The NFPA makes it clear in Chapter 7, Section 7.5.4.3 that synchronization is only one of several installation configurations that the systems designer can use to minimize multiple strobes flashing in an individual’s field of view. These four options are outlined on page 6. The 2007 edition of NFPA added that the strobe synchronization requirements of Chapter 7 do not apply where visible notification appliances located inside the building are viewed from outside of the building. In 1996 the NFPA changed its maximum acceptable strobe flash rate from 3 Hz to 2 Hz in an effort to reduce strobe flash rates in an individual’s field of view.

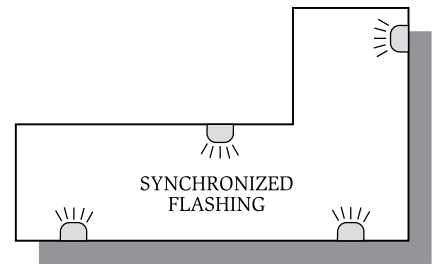
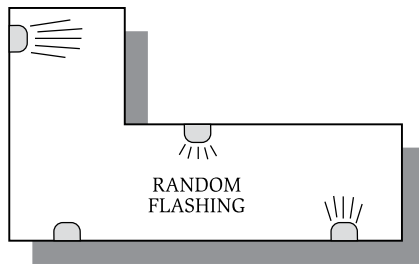

## Audibility Requirements

The focus of notification appliance code development over the last several years centered around the visible portion of

the devices to aid hearing impaired individuals during a fire emergency. Even with this focus it is important to remember that there are code requirements for the audible portion of the device as well. Although the ADA has audibility requirements, NFPA 72 Chapter 7 has the more stringent set; therefore, the highlights of NFPA's notification appliance audibility requirements are outlined below.

As defined by the NFPA, the location of an audible appliance shall be not less than 90" above the floor and not less than 6" below the ceiling. This requirement is superseded by strobe location requirements when an audible appliance is installed in combination with a strobe.

### Temporal Evacuation Signal

The most recent audibility requirement to be adopted by the NFPA is the Temporal Code. This code was developed to establish a universal evacuation signal to lessen confusion as to whether an alarm represents an emergency requiring complete evacuation of the building.

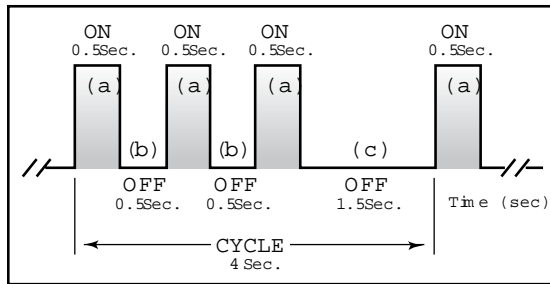

Key:

Phase (a) signal on for 0.5 sec

Phase (b) signal off for 0.5 sec

Phase (c) signal off for 1.5 sec [(c) = (a) + 2(b)]

Total cycle is 4 sec

\*Note: The temporal evacuation signal is a system requirement and is addressed in NFPA 72, Chapter 7.

This tone pattern is a 0.5 second on phase, followed by a 0.5 off phase for three successive on phases, followed by an off phase of 1.5 seconds. The pattern is then repeated for a minimum of 180 seconds.

### Public Mode Sound Level

NFPA's minimum public mode dBA output is the highest of two possible scenarios measured 5' above the floor.

- 15 dBA above average ambient sound
- 5 dBA above the maximum sound level with a duration of at least 60 seconds.

NFPA's maximum public mode dBA output is 110 dBA anywhere.

The ADA's public mode audibility requirements are the same as NFPA's except NFPA requires a minimum of 75 dBA present at the pillow in sleeping areas.

### Private Mode Sound Level

NFPA's minimum private mode dBA output is the highest of three possible scenarios measured 5' above the floor.

- 10 dBA above average ambient sound
- 5 dBA above the maximum sound level with a duration of at least 60 seconds

NFPA's maximum private mode dBA output is 110 dBA anywhere, whereas ADA allows 120 dBA maximum.

### Sleeping Area Sound Level

NFPA's minimum sleeping area dBA output is the highest of three possible scenarios measured 5' above the floor.

- Sound level of at least 75 dBA
- 15 dBA above average ambient sound
- 5 dBA above the maximum sound level with a duration of at least 60 seconds

NFPA's maximum sleeping area dBA output is 120 dBA anywhere.

### What is the Coverage and Enforcement of the ADA?

safety signaling devices are addressed under Title III, which covers public accommodations and services, including transportation. Compliance is enforced by the Department of Justice, or the Department of Transportation in areas of public transportation.

“Private mode” applications are those where a signal is known to be in place and where someone is trained to take additional action upon notification from the alarm signal. Examples include

### Fire Safety Signaling Devices Are Covered Under Title III:

ADA – Americans with Disabilities Act	
<u>Title I</u>	Employment
Enforced by: Equal Employment Opportunity Commission (EEOC)	
<u>Title II</u>	Public Services
Enforced by: Department of Justice (DOJ), Department of Transportation (DOT)	
<u>Title III</u>	Public Accommodations and Commercial Facilities
Enforced by: Department of Justice (DOJ)	
<u>Title IV</u>	Miscellaneous Provisions

### What Is “Public Mode” vs. “Private Mode” Operation?

control rooms, nurses’ stations and guard desks. These emergency signaling applications may not have to meet ADA requirements and may be satisfied through installation of UL 1638 appliances.

“Public mode” operation includes audible or visible signaling to occupants or inhabitants of the area protected by the fire alarm system.

The Americans with Disabilities Act, Section 301-7, defines a public accommodation as any facility that is privately operated, affects commerce with its operation, and falls into one of the 12 categories shown in the accompanying illustration.

These categories are fairly general and will encompass a wide variety of facilities. Social service facilities, for example, include not only homeless shelters, adoption agencies, senior citizen centers, food banks and day care centers, but also halfway houses, substance abuse treatment facilities and other crisis centers.

According to NFPA 72 2007 Edition, Chapter 7 and its appendices, specific installation, spacing and location of strobes is dependent upon the size and configuration of the area to be protected. Requirements are based on square room size (see page 6). If the room configuration is not square, the size square that will

ADA Public Accommodations

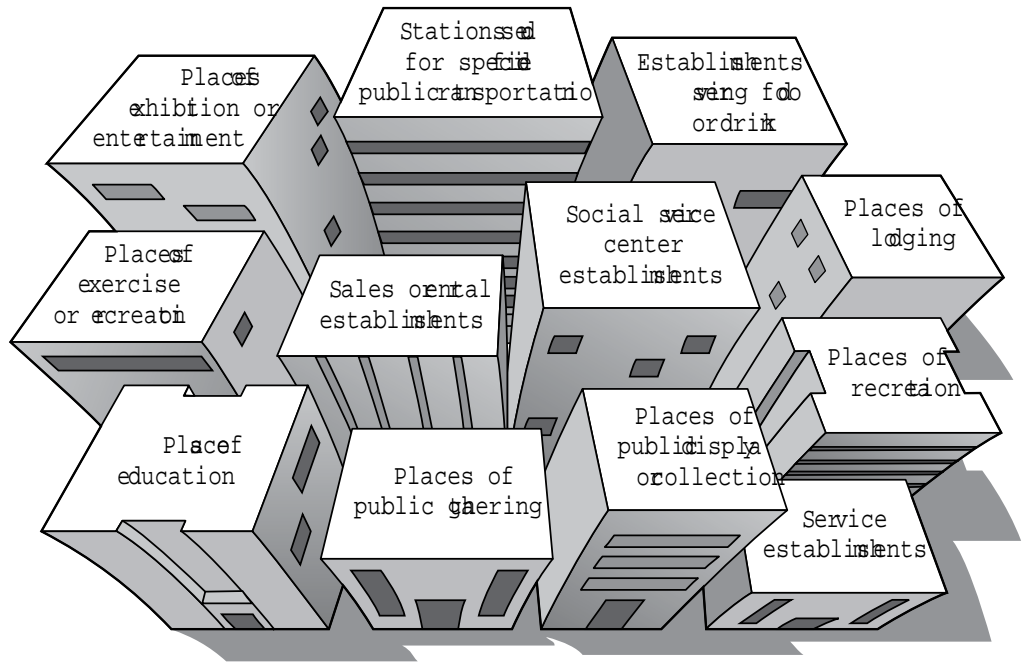

## Voltage Drop Calculations

Voltage drops occur in the wiring, causing the voltage at the end of the loop to be lower than the supply voltage. In laying out a circuit, it is important to prove that the voltage supplied to the last device on the loop is greater than its minimum operating voltage designated by UL testing.

A quick, worst case estimate of voltage drop in the wiring can be obtained by assuming that all of the appliances on the loop are lumped at the end furthest from the power supply. To do this estimate, you must know the following about the circuit:

- The minimum possible voltage at which the particular power supply will operate as defined by UL testing. This is typically 15% below the nominal output of the power supply.
- The minimum voltage supplied to the circuit.
- The total current drawn by the appliances on the circuit.
- The length of the circuit, from the power supply to the last device.
- The wire size.
- The total wiring resistance (determined from the length of the circuit and the wire size).

When calculating the voltage available to the last device, it is necessary to consider the voltage drop due to the resistance of the wire. The thicker the wire, the smaller the voltage drop. Generally, for purposes of determining the wire size necessary for the system, it is best to consider all of the devices as "lumped" on the end of the supply circuit to simulate worst case. For the most accurate voltage drop calculations use the System Sensor voltage drop calculator available on the web or CD-ROM.

Approximate wire resistance:

18 AWG solid: 8 ohms/1000 ft.

16 AWG solid: 5 ohms/1000 ft.

14 AWG solid: 3 ohms/1000 ft.

12 AWG solid: 2 ohms/1000 ft.

NOTE: If Class A wiring is installed, the wire length may be up to twice as long as on non-fault tolerant circuits.

The total wiring resistance is determined by multiplying the ohms/foot of the wire being used by the total length of the wiring. The length of the circuit must be multiplied by two to get the total length of the wiring (to account for two conductors in the wire).

With this information the voltage drop in the wiring can be determined using the formula:

$$V_{DROP} = (\text{Total Current Draw}) \times (\text{Total Wiring Resistance})$$

The voltage at the end of the circuit is then determined by the formula

$$V_{EOL} = V_{SUPPLY} - V_{DROP}$$

The above calculations should be made using the minimum supply voltage specified by the manufacturer of the supply. This value is typically 15% below the nominal voltage, so calculations for 24-volt supplies are made using 20.4 volts, and calculations for 12-volt supplies are made using 10.2 volts.

If the calculated result for  $V_{EOL}$  is less than the minimum rated voltage of the appliances being used, then changes need to be made in the design of the circuit. Somewhat more favorable results may also be attained by analyzing the circuit in more detail, where the exact location of each appliance in the circuit is taken into account. This approach is most easily accomplished by using a computerized program, like the one on the System Sensor website.

### Example

A 24-volt notification circuit needs to drive 12 appliances. Each appliance has a rated operating voltage range of 16 – 33 volts and draws 125 mA. The length of the circuit is 250 feet from the power supply to the last device. The proposed wire is 18 AWG solid copper. Will this system provide adequate voltage to the last device on the circuit?

From the wiring tables, the resistance of the wire is 8.08 ohms/1000 feet. The total length of the wire is 500 feet (250 feet of two wire cable). Therefore, the total resistance of the wire is

$$R_{WIRING} = 8.08 \times 500/1000 = 4.04 \text{ ohms}$$

The total current in the circuit is

$$I_{TOTAL} = 12 \text{ appliances} \times 125 \text{ mA/appliance} \times .001 \text{ amp/mA} = 1.5 \text{ amps}$$

Voltage dropped (or lost) in the wiring thus becomes

$$V_{DROP} = I_{TOTAL} \times R_{WIRING} = 1.5 \times 4.04 = 6.06 \text{ volts}$$

Voltage available at the end of the circuit is calculated by subtracting  $V_{DROP}$  from the supply voltage. Assuming a worst case supply voltage 15% below nominal, the result is

$$V_{EOL} = 20.4 - 6.06 = 13.8 \text{ volts}$$

Since this voltage is less than the operating voltage of the appliances (16 volts), the circuit design is not acceptable. If we switch from 18 AWG wire to 16 AWG and repeat the calculations

$$R_{WIRING} = 5.08 \times 500/1000 = 2.54 \text{ ohms}$$

$$I_{TOTAL} = 12 \text{ appliances} \times 125 \text{ mA/appliance} \times .001 \text{ amp/mA} = 1.5 \text{ amps}$$

$$V_{DROP} = I_{TOTAL} \times R_{WIRING} = 1.5 \times 2.54 = 3.8 \text{ volts}$$

$$V_{EOL} = 20.4 - 3.8 = 16.6 \text{ volts}$$

Since the worst case voltage at the end of the circuit is now greater than the minimum voltage required for the appliances, this design would be acceptable.

Voltage drop calculations should be done during the planning stages of an installation, prior to installing any wiring or devices. There is no simple fix if it turns out that a fully installed system cannot meet the requirements of the appliances connected to it.

In designing the notification circuit, it is also important to make sure that the power supply is capable of supplying the appropriate voltage and current levels required by the appliances.

## Power Supply Considerations

Because of the relatively high currents drawn by fire alarm strobe lights, and the current surges associated with them, the choice of an appropriate power supply is critical to the proper operation of the overall system. Before beginning the layout of the NAC wiring, it is important for the designer to verify that the proposed power supply, or fire panel, will meet his needs:

- It must be compatible with the notification appliances that will be used
- It must be capable of providing enough current for all of the appliances on the circuit.

It is important to understand the operating characteristics of the power supplies chosen for use in any fire system. The characteristics of every power supply model vary and these characteristics

determine the number of notification appliances that will effectively operate on a power supply's loop.

In May 2004 Underwriters Laboratories changed standards UL 1971 & 464 to require that operating current measurements are made using RMS (root mean square) instead of peak or average values. RMS measurements more accurately predict the power consumption of a device since they take into account the entire current draw profile including surge, repetitive surge, and peak values.

The published RMS current is the maximum operating current of that device within its operating voltage range. This current maximum may or may not occur at the endpoints of the voltage range. The UL revisions standardize how operating currents are measured.

## What Is Meant By Polar Light Distribution?

the standard measures light intensity —both horizontally and vertically—at viewing angles ranging from 0 to 180 degrees. The adjacent diagrams show the values required for wall mounted and ceiling mounted units.

UL 1971 requires a polar light distribution pattern to enhance the likelihood of alerting hearing impaired individuals throughout an area. Polar refers to the way

Light Output – Vertical Distribution, Wall To Floor

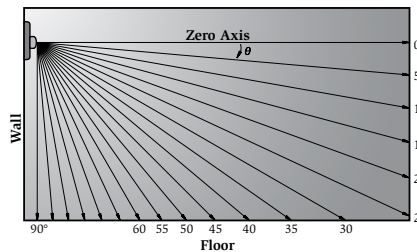

Degrees	Percent of Rating
0	100
5-30	90
35	65
40	46
45	34
50	27
55	22
60	18
65	16
70	15
75	13
80	12
85	12
90	12

Light Output – Vertical Dispersion, Ceiling To Walls And Floor

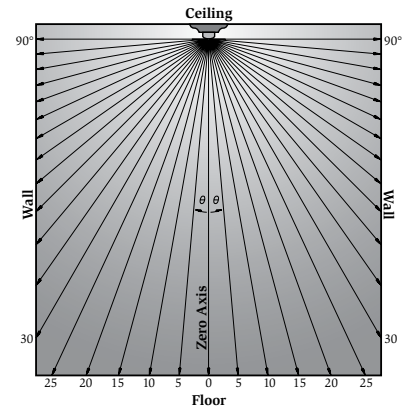

Degrees	Percent of Rating
0	100
5-25	90
30-45	75
50	55
55	45
60	40
65	35
70	35
75	30
80	30
85	25
90	25

## Glossary

Access Board See Compliance Board.

ADA The Americans With Disabilities Act. An act of Congress intended to ensure civil rights for physically challenged people.

ADAAG The Americans With Disabilities Act Accessibility Guidelines. Developed as “rules” to help people comply with the ADA.

ANSI American National Standards Institute. Develops guidelines and standards, which are incorporated as regulation in many regional, state, local and model building codes. and refers to NFPA 72 for accessible audible and visual alarms and notification appliances within a building. 117.1–Accessible and Usable Buildings and Facilities.

Average Ambient Sound The average sound level measured in a given area over the period of occupancy.

Candela (cd) Unit of light intensity.

Compliance Board The United States Architectural and Transportation Barriers Compliance Board. The body responsible for developing the ADA Accessibility Guidelines (ADAAG) and interpretive instructions on the ADA and ADAAG in “Bulletins.” Bulletin #2 focuses on visible signaling; Bulletin #5 focuses on using ADAAG.

EFA Epilepsy Foundation of America.

Footcandle Illuminance of a 1 candela source measured 1 foot away from the source.

Lumen Amount of light emitted by a 1 candela source passing through a specified area in space.

NEMA Signaling Section National Electrical Manufacturers Association. Body of manufacturers who design, develop, manufacture and distribute visible and audible signaling devices as well as other components of fire alarm systems.

NFPA National Fire Protection Association. Develops guidelines and standards for the installation and maintenance of fire safety equipment.

NFPA 72 Chapter 7 The chapter of the National Fire Alarm Code detailing installation standards for notification appliances for fire alarm systems.

Ohm’s Law  $Voltage = Current \times Resistance$

“On Axis” A way of describing the “plane” of or uni-directional light generated from a strobe light. Often used to describe certain UL Standard 1638 strobe lights which send their light out primarily in front of the device.

Polar Way of describing light output in 2-dimensional space. Plotted as output in candela vs. angle.

Private Mode Applications where the signal is known to be in place and where someone is trained to take additional action upon notification from the signal.

Public Mode The mode of operation for both visible and audible where the signal is intended to alert anyone in the protected area whether aware or unaware of its presence.

Temporal Code A universal fire evacuation sound pattern adopted by NFPA in 1996. This tone pattern is a 0.5 second on phase followed by a 0.5 second off phase for three successive on phases followed by an off phase of 1.5 seconds. The pattern is then repeated for a minimum of 180 seconds.

UL Standard 1638 The UL standard governing private and general mode signaling applications as of April 1, 1994. A performance standard. Tests light output and distribution per manufacturer’s specifications when the device is intended for emergency signaling. (Note: devices may also be tested for only fire and shock hazard for non-emergency signaling.) Minimum flash rate of  $\frac{1}{3}$  to 3 flashes per second. Listed device is “not to be used as an evacuation signal for the hearing impaired.”

UL Standard 1971 The UL standard governing all public mode fire applications as of April 1, 1994. A performance standard. Includes specific light output and distribution requirements to ensure illumination throughout an area defined by NFPA 72. Minimum flash rate of  $\frac{1}{3}$  to 3 flashes per second. Categorizes minimum light intensities by area: non-sleeping (15 cd), corridor (15 cd) and sleeping areas (110 cd (wall) or 177 cd (ceiling)).

Voltage Drop The decrease in voltage from the beginning of a circuit to the end of a circuit due to resistance.

NOTE: System Sensor does not approve, inspect, or certify any installations, procedures, equipment, or materials. In determining the acceptability of installations or procedures, equipment, or materials, the authority having jurisdiction may base acceptance on compliance with NFPA or other appropriate standards. The authority having jurisdiction may also refer to the listings or labeling practices of an organization concerned with product evaluations which is in a position to determine compliance with appropriate standards for the current production of listed items. The information in this guide has been provided in an attempt to assist in making this decision and should in no way be construed as a formal approval or certification.



advanced ideas. advanced solutions.™

**8 0 0 / 7 3 6 - 7 6 7 2**  
www.systemsensor.com